



WM08 series



WM08/SE series



WM08 series IP65 vandal resistant LED wall lights with high efficacy LED chips and integral electronic LED driver.

LED lighting revolution and is making energy-wasting traditional lighting technologies obsolete through the use of energy efficient, environmentally friendly LED light.

WM08 series IP65 LED surface mounted luminaire designed with:

- Aluminium housing.
- UV-stabilised, Impact resistant opal polycarbonate diffuser.
- Silicon gasket for IP65 rating.
- Stainless steel fasteners.
- PIR Sensor + Daylight Sensor option available

LED: SMD2835

Colour Temperature: Switchable: 3000K / 4000K / 5700K

Colour Rendering Index: CRI80+

Lamp's Life Time: 50,000Hrs L70 / B10 at 25 C°

Beam Angle: 120°

Driver options: Integral non-dimmable / Triac dimmable

IP Rating: IP65

IK Rating: IK08

Available Colour: Black

Applications:

Hospitals, Schools, Hotels, Shops, Supermarkets, Pathways, Factories and Aged Care Facilities.

Lumen output based on Absolute lumens, 4000K LED chip and manufacturers rated mA drivers.

*** NOTE: Dimensions and Cut Out sizes may change without notification.



WM08 series

WM08/SE PIR & Daylight Sensor

Cat	Watt	Colour Temperature	Lumen Output	CRI	Size Height x Width x Depth	IP
WM08-C3-12	12W	3000K 4000K 5700K	1289 1309 1275	80+	251 x 167 x 80	IP65
WM08-C3-18	18W	3000K 4000K 5700K	1731 1805 1760	80+	251 x 167 x 80	IP65
WM08/SE-C3-12 with Sensor	12W	3000K 4000K 5700K	1266 1299 1274	80+	251 x 167 x 80	IP65
WM08/SE-C3-18 with Sensor	18W	3000K 4000K 5700K	1691 1746 1685	80+	251 x 167 x 80	IP65

Optional Extras

Options	Suffix	Comments
Triac dimmable	DM	Integral Triac dimmable LED driver

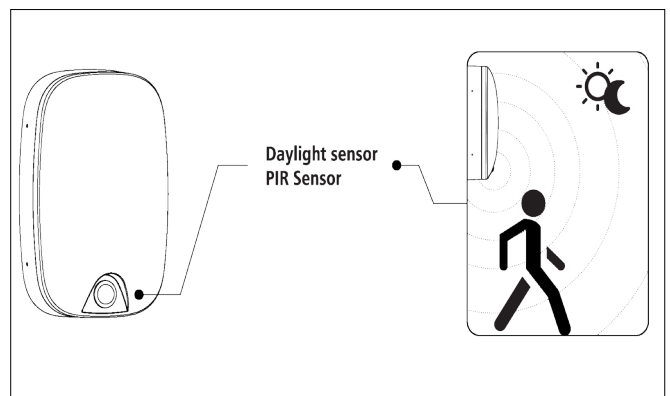
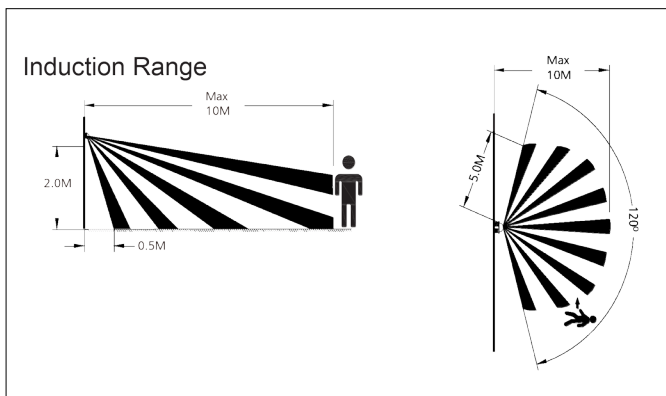

Lumen output based on Absolute lumens, 4000K LED chip and manufacturers rated mA drivers.

*** NOTE: Dimensions and Cut Out sizes may change without notification.

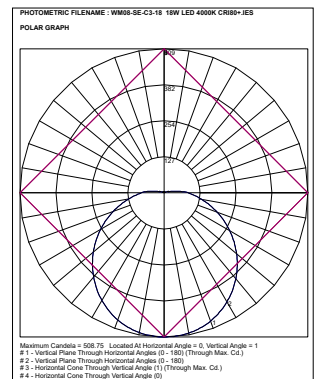
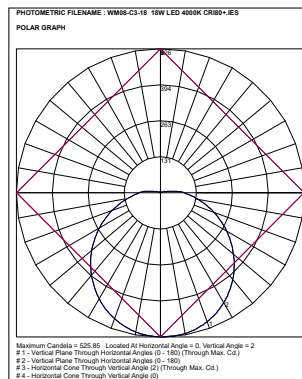
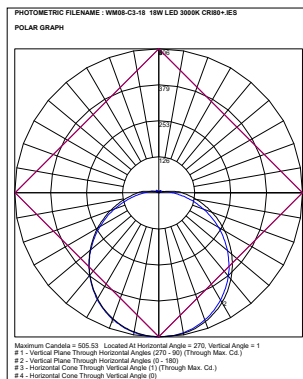
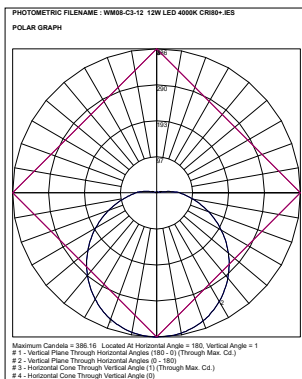
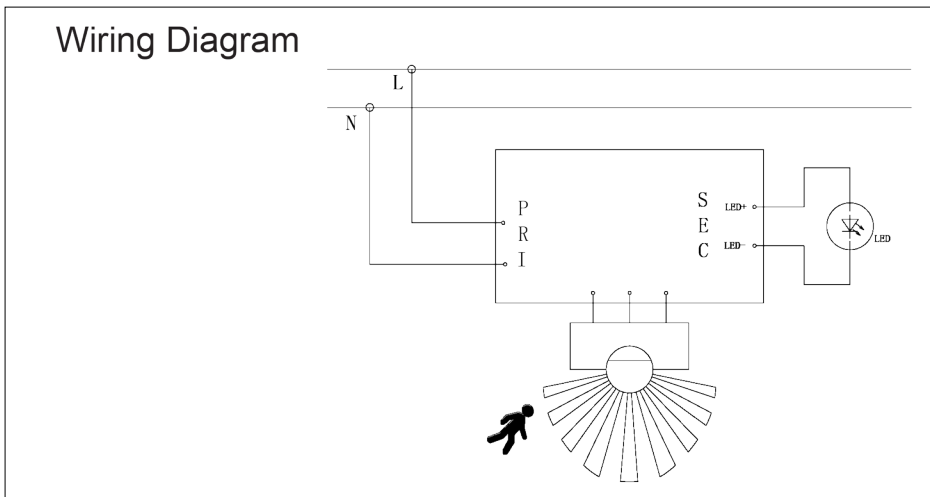
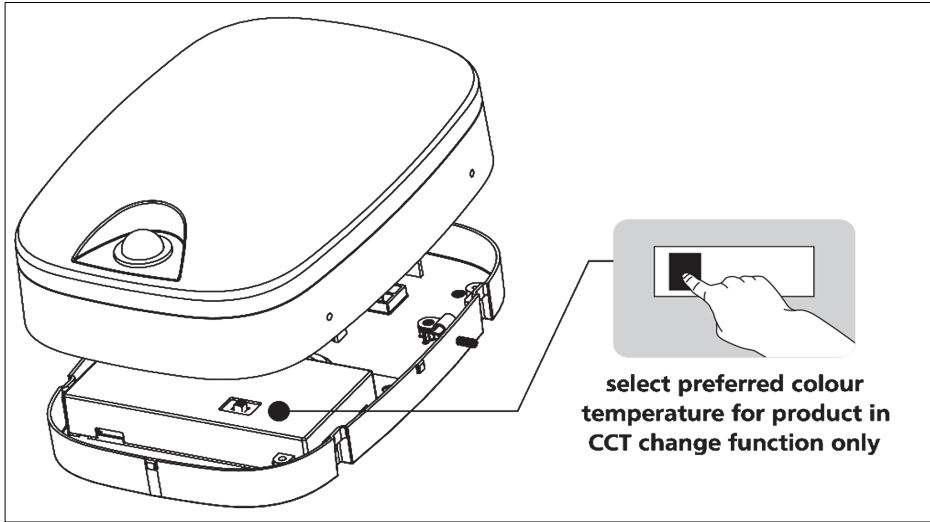

Lumen output based on Absolute lumens, 4000K LED chip and manufacturers rated mA drivers.

*** NOTE: Dimensions and Cut Out sizes may change without notification.